



Fully Automatic Motorised Satellite TV System



SatKing ORBIT V3

User manual

v1.0

www.satkingorbit.com.au



Contents

1. General Information

1-1. Introduction	4
1-2. Proper use and operation	5
1-3. Safety notes	5

2. Contents

2-1. Components bundle	6
2-2. Name of parts	7

3. How to assemble dish (reflector)

8

4. Connection diagram

10

5. Functional description

5-1. Get ready to use	11
5-2. Searching the satellite	12
5-3. Back to HOME position & Turning off	12

6. Extra functions

6-1. Error message	13
6-2. Factory reset	13
6-3. Software upgrade	13
6-4. Advanced settings	14

7. Troubleshooting

15

8. Specifications

8-1. Dimension	16
8-2. Specifications	16

9. Caravan/Motorhome installation

9-1. Required space for SatKing ORBIT V3	17
9-2. Equipment for installation	18
9-3. Installation	18
9-4. Battery connection	23
9-5. Options	23

1. General Information

1-1. Introduction

These instructions describe the functions and operation of the SatKing ORBIT V3 fully automatic satellite system.

Correct and safe operation of the system can only be ensured by following these instructions.

Your SatKing ORBIT V3 is an intelligent satellite TV reception antenna system which can align itself towards a preset satellite automatically when the system is located within the footprint of the selected satellite. The latest Australian coverage map is available on www.satkingorbit.com.au

For general operation, please ensure that the system always has a clear view of the Northern Sky (N/E when in WA). If the satellite's signal beam is interrupted by obstacles such as buildings or trees, the unit will not function and no satellite TV signal will be received, move your van slightly and try again. For more information on general use of this unit consult your local dealer for assistance.

1-2. Proper use and operation

This product has been designed for fixed installation on vehicles with maximum speeds of 130 km/h. It is designed to automatically aim an antenna at geostationary television satellites. The power to the system is supplied by a standard vehicle electrical system with a rated voltage of 12 Volts.

12V DC is default and recommended for use. If 24V DC has to be used, separate DC to DC downconverter must be used.

Use of the equipment for any other purpose to the one specified is not permitted.

Please also note the following instructions from SatKing:

- It is not possible to add or remove components on this product.
- The use of other components other than those originally supplied.
- When completing installation you or your contractor must strictly follow all instructions in the supplied user manual. Failure to follow the user manual may cause damage to the SatKing ORBIT V3 or your vehicle.
- The product does not require any regular maintenance; all service must be carried out at approved service centre's.
- All relevant guidelines of the automotive industry must be observed and complied with.
- The equipment must only be installed on solid vehicle roofs.
- Avoid cleaning your vehicle with the mounted satellite system in a drive-through car wash or a car wash with a high-pressure cleaner.
- The SatKing ORBIT V3 comes with a 2 year warranty, for full warranty details please visit our website www.satkingorbit.com.au
- After Sales Support Line 1300 139 255 or support@SatKing.com.au
- If you are using VAST all card activation and channel entitlement issue's are handled by the VAST call centre 1300 993 376. Their hours are 9am till 12pm and 2pm till 4.30pm QLD time.

1-3. Safety notes

Please carefully read and follow the operating instructions in this manual.

Upon installation of the SatKing ORBIT V3, please ensure the installation is done with supplied cables and ensure the controller cable is not modified in anyway, this carries data.

The driver of the vehicle must inspect the antenna unit before driving off to ensure that the antenna is properly stored in safe. Check to see if the antenna is fully folded.

As the user of this equipment, you are responsible for yourself ensuring compliance with the relevant laws and regulations.

The manufacturer does not take liability for direct or indirect consequential damage of the system, motor vehicles or other equipment by reason of unsuitable battery usage or incorrect installation or wrong polarity.

2. Contents

2-1. Components bundle

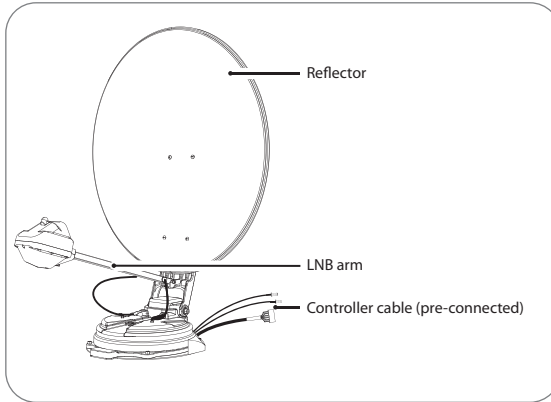

Main unit

Reflector assembly

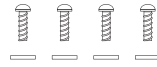

Truss head M6 × 15 (4),
M6 Flat mold washer (4)

LNB arm assembly

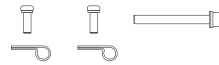

Cable clamp (2), Sems1 M4 × 10 (2)
Sems2 M6 × 55 (1)



Controller

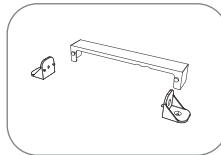

Controller bracket,
Rear cable cover

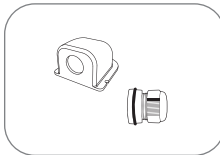

Cable holder,
Cable gland

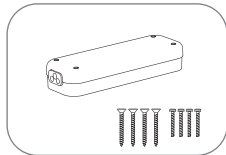

Junction Box,
M4x30(4), M3x18(4)

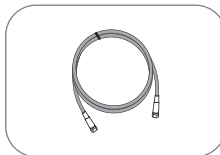

STB cable (3m)



Signal cable (7m)
(x2 for twin output)

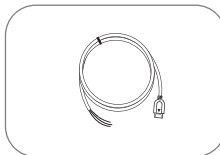

Power input cable



Controller cable

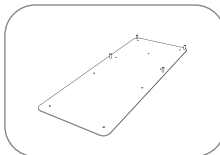

Mounting plate

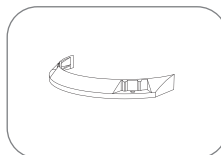

Deflector

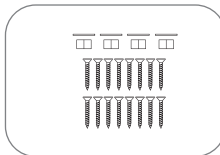

M4 × 20 (16), Washer (4)
M8 locking nut (4)

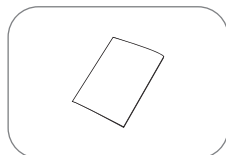

User manual

※ Actual components may differ from the above images.

2-2. Name of parts

Main unit

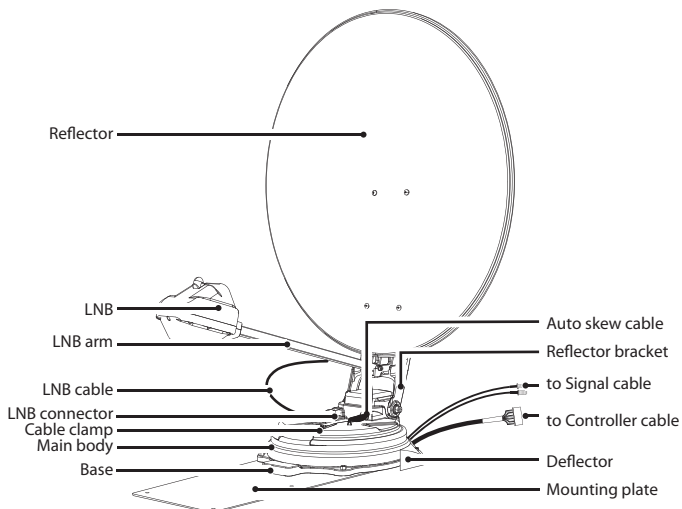

Controller

• Front

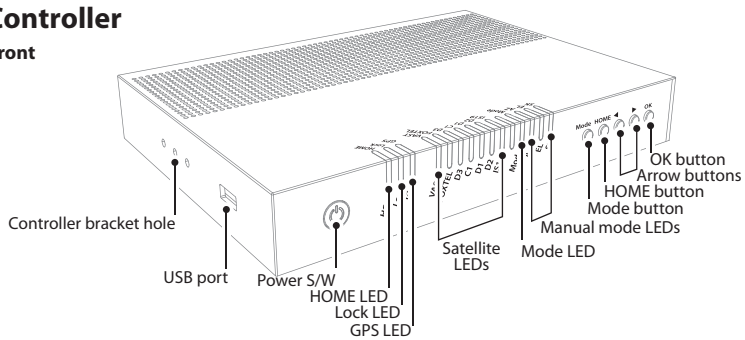

LED Indicator



On



Off



Blinking

• Back

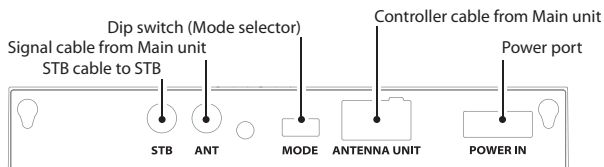

Note. Make sure that dip switch is set for right mode. (see page 11)

3. How to assemble dish (reflector)

Step 1 : Press POWER button on the controller to turn on the unit and press OK button on any satellite

Step 2 : When reflector bracket is lifted up to vertical direction(about 90 degrees), turn the unit off

Step 3 : Connect the reflector to the reflector bracket

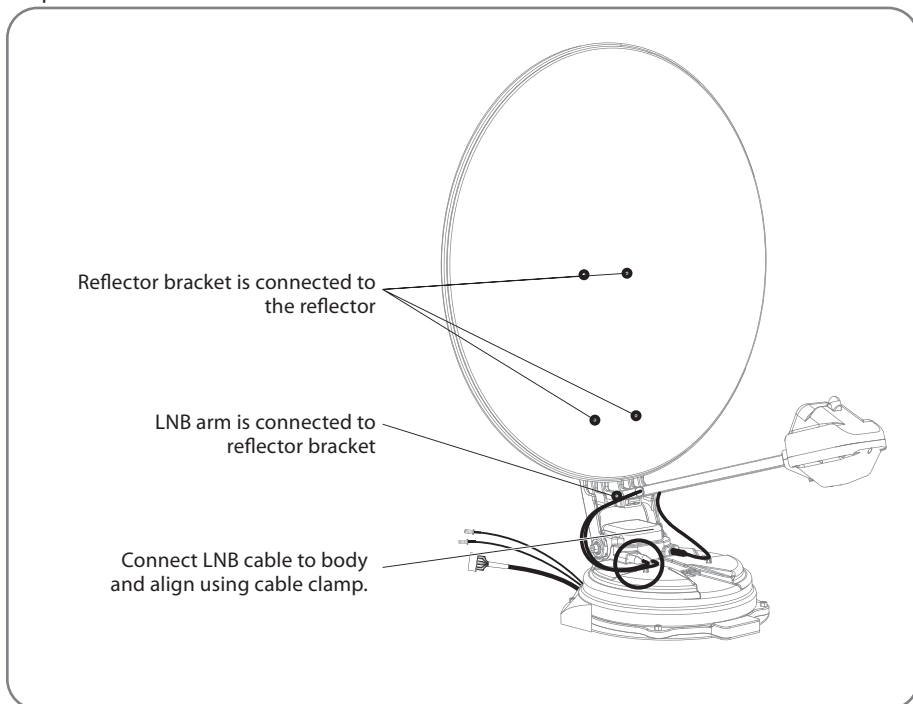

Step 4 : Combine LNB arm with reflector bracket

Step 5 : Connect LNB cables and auto skew cable to the connector on the body, and cover the connectors on both sides with waterproof cap for protection

Step 6 : Align LNB cables on the body using cable clamps

※ To avoid cable damage, fix LNB cable and auto skew cable as enlarged image on following page.

Step 7 : Power on and check the installation is completed by selecting HOME position

SatKing ORBIT V3 85cm

No	Part name	Quantity
①	Reflector	1
②	LNB arm	1
③	Reflector bracket	1
④	M6 flat mold washer	4
⑤	Truss head M6x15	4
⑥	SEMS2 M6x55	1
⑦	Cable clamp	2
⑧	SEMS1 M4x10	2

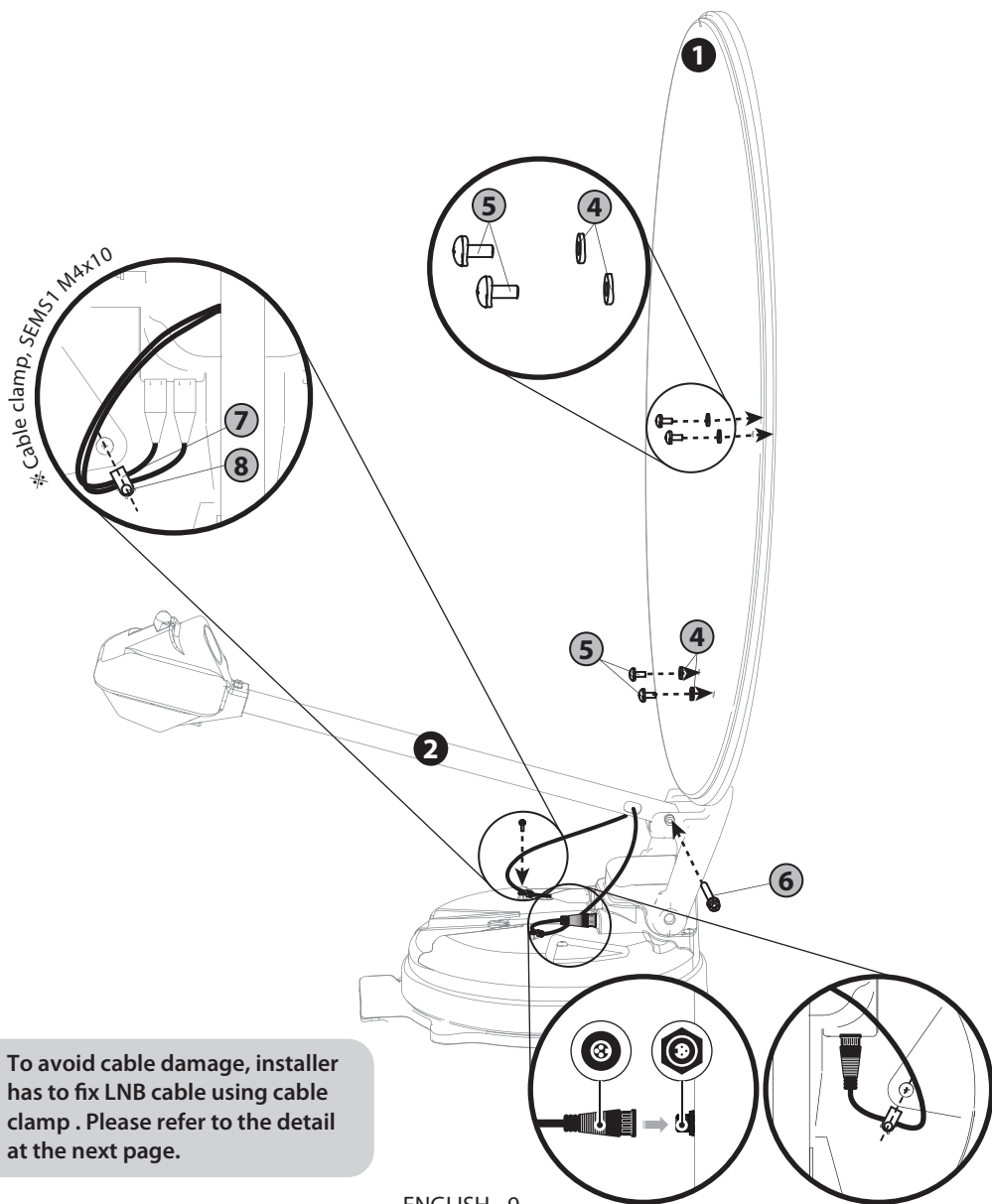

4. Connection diagram

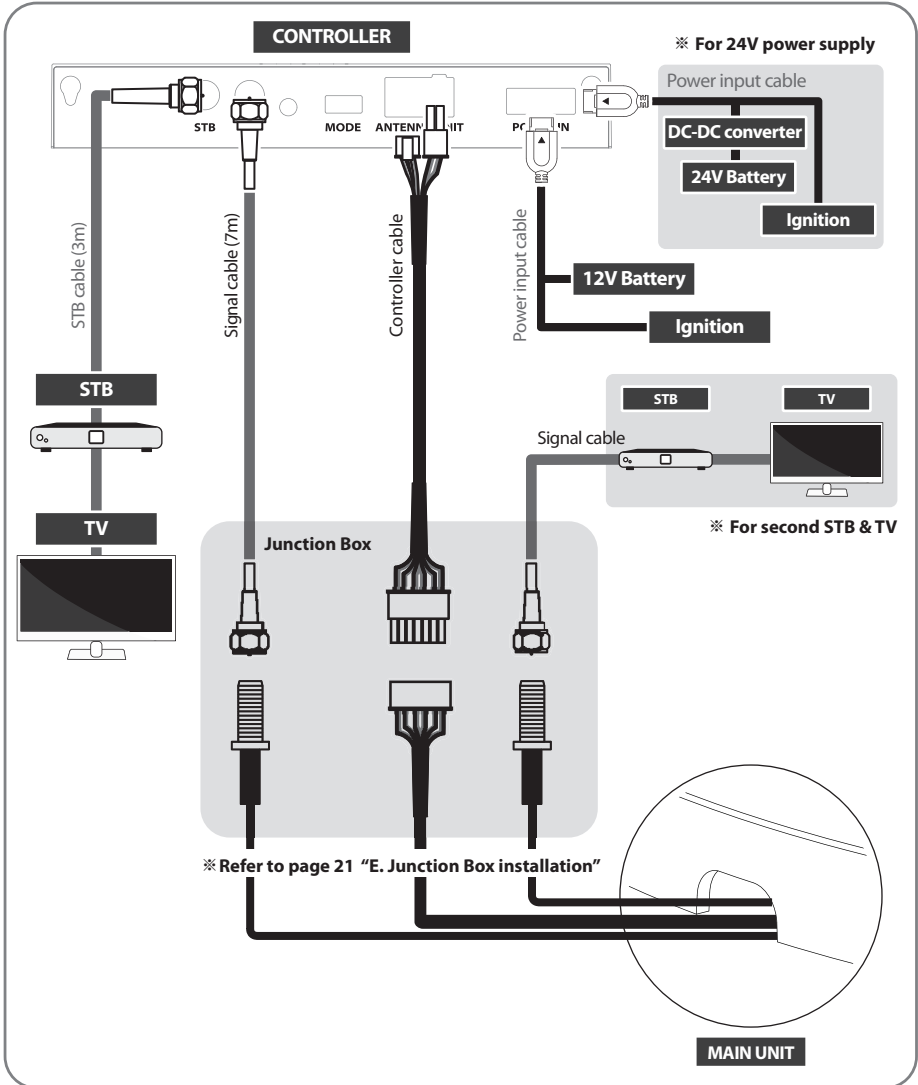

- Use controller cable to connect the antenna to the controller. Controller cable is pre-connected to the main body.
- STB cable and signal cable are different lengths. Please check the lengths to use the correct cable for the job.
- Please ensure the supplied cables are used and not modified in anyway.

5. Functional description

5-1. Get ready to use

See below the controller has correct pre-setting.
Do not change setting unless mismatch with below example.

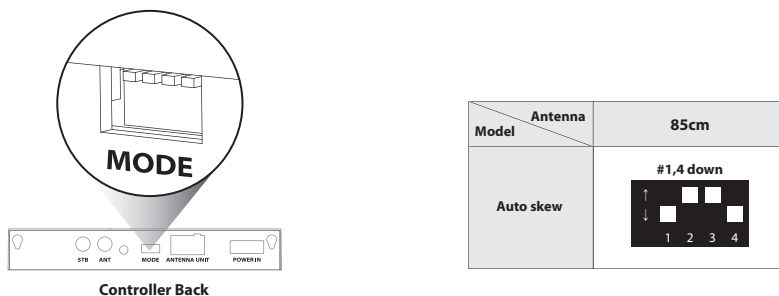

❖ Incorrect setting causes deterioration of reception performance.

- When the all cable connections are completed, press Power button.
- All satellite LEDs will flash and then system is displayed like below image.

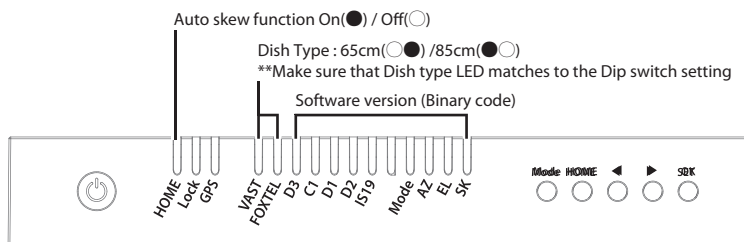

- HOME LED and a satellite, either the default satellite “VAST” or the last selected satellite, will be solid this means the antenna is ready to go.
(If the antenna is not at HOME, HOME LED flashes while moving to HOME position)

❖ HOME position is when the antenna completely folded down and facing backward.

- GPS LED flashes while searching for the current location. When GPS position is confirmed the LED will become solid.

❖ The ORBIT V3 can still locate the satellite without the GPS locked.

- Waiting until both HOME & GPS LEDs are solid is recommended as this will allow the unit to find the selected satellite faster with more precise alignment accuracy.

5-2. Searching the satellite

- a. Select the satellite using the arrow buttons on the controller and press OK.
- b. Lock LED will flash during search and become solid when the satellite is found.
- c. If you have selected the wrong satellite, move to the correct satellite name using arrows and press OK to confirm new satellite.

5-3. Back to HOME position & Turning off

- a. After use and before travelling, press HOME to return the unit to HOME position.
- b. To fully turn off the unit, long press Power button when the unit is at HOME.
- c. If you will stay in your location for an extended period or wish to save power you can leave the unit up simply by pressing the Power button and powering the unit off, the signal will still come through to your satellite TV receiver.

6. Extra functions

6-1. Error message

Error message LEDs (HOME /Lock /GPS) will be illuminated at the same time if there is a problem with the main unit and detail is indicated as :

NO	LED indicator	Error detail
1	VAST	Low power
2	FOXTEL	Tuner error
3	D3	AZ motor error
4	C1	EL motor error
5	D1	SK motor error
6	D2	AZ motor current error
7	IS19	EL motor current error
8	-	-
9	Mode	High power
10	AZ	SK motor current error
11	EL	EL range error (Over the limit)
12	SK	LNB error

6-2. Factory reset

- Ensure that the unit is turned off.
- Press and hold HOME button then also press the Power button.
(Press home button until yellow LED blinks once.)
- Factory reset takes less than 10 seconds.
- When HOME LED becomes solid this means the factory reset is finished.
(If the antenna is not at HOME, HOME LED blinks while HOME positioning)

6-3. Software upgrade

- Transfer software program to a USB stick. (Do not place inside a folder)
 - Go to website www.satkingorbit.com.au to download software program.
 - If controller does not recognise USB drive, plug USB into a PC.
 - Right click USB, go to "Properties" and check the File system is FAT32.
 - If not, right click USB, go to "Format" and re-setup a file system to FAT32.
- Ensure that the unit is turned off and plug the USB into USB port of the controller.
- Press and hold OK button then also press the Power button.
- HOME / Lock / GPS LEDs solid at the same time while checking the program.
- Software upgrade takes about 10 seconds.
- When the upgrade is completed, all Satellite LEDs flash once.
- HOME / Lock / GPS LEDs are off during the controller reboot.
- When HOME LED becomes solid, the antenna is ready to use.
- If it fails, the HOME / Lock / GPS LED will flash 5 times and the system will power off.

※ CBI type USB is not supported.

6-4. Advanced settings

a. Change VAST STB Home Transponder (TP)

In very low signal areas or in bad weather it may be an advantage to change the home TP in your VAST receiver, this will allow the VAST receiver to search for the strongest TP first.

※ Due to signal levels all channels may scan in but not be available.

b. SatKing VAST Receivers

- i. Press Menu_Select Installation and press "OK" _Enter Password 1234.
- ii. Press yellow button (TP Edit)_Change frequency to 11804.
- iii. Green bars should appear down the bottom of the TV screen, once this happens press the red button. (start search)

c. UEC DSD 4921 RV

- i. Press Menu_Settings and press "OK".
- ii. Select Installation
- iii. Enter password 1234
- iv. Select Satellite channels search
- v. Change Freq to 11804
- vi. Start Scan

7. Troubleshooting

There are a number of common issues that can affect the signal reception quality or the operation of the SatKing ORBIT V3. The following sections address these issues and potential solutions.

A. No function when you power on the controller

- i. Check again that all the cable connections have been made correctly.
 - ✓ Connection between the battery and controller.
 - ✓ Connection between the controller and the antenna. Make sure that the cable is plugged into the correct port on the antenna.
- ii. Check if the power input cable has been damaged.
- iii. Check the battery polarities(+/-), check the yellow cable is not simply connected to + cable.

B. Failed to lock to the selected satellite

- i. Satellite signals can be blocked or degraded by buildings and trees.
Make sure there are no obstructions in a northerly direction, maybe move van slightly.
- ii. Select another satellite, VAST or FOXTEL both come from the same position but use different parameters so changing the satellite will force the unit to search different parameters.
- iii. If this is first use make sure LNB arm is fitted up the correct way and that receiver cable is in the "ANT" port on the rear of the controller.

C. Mechanical problems

- i. If the antenna does not move into desired position,
Try to power OFF/ON again or remove the power jack from the controller and then re-connect.
- ii. If the antenna makes a noise whilst remaining static,
Try to power OFF/ON again or remove the power jack from the controller and then reconnect. If problem persists, please contact your local distributor for assistance.
- iii. If the system has been improperly wired, the system may not operate. Contact your local dealer for assistance.

D. Terrestrial antenna (Also known as local antenna)

- i. We recommend that you retain your local antenna as there will be some locations where there are trees blocking the satellite signal and there is no clear view of the sky but there is adequate terrestrial TV signal available.

8. Specifications

8-1. Dimension

SatKing ORBIT V3 85cm

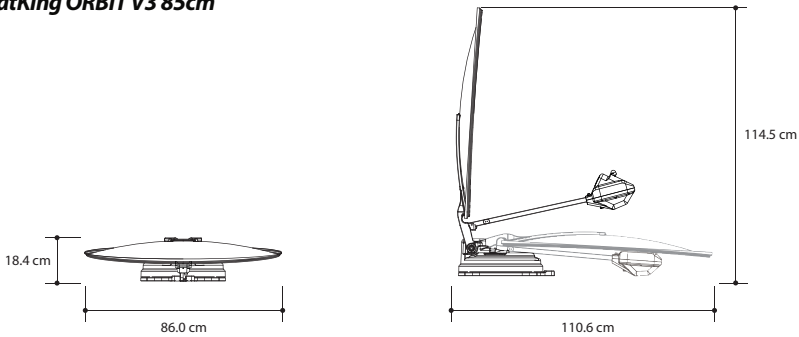

8-2. Specifications

MODEL	SatKing ORBIT V3 85cm
Dish size (Offset dish)	86.0 (W) x 91.0 (L) cm
Dimension /	110.6 (L) x 86.0 (W) x 18.4 (H) cm
Weight	15.1 Kg
Work Condition	Stationary
Polarization	Linear (Horizontal / Vertical)
LNB Output	Dual Output
LNB Input Frequency	11.7 ~ 12.75 GHz
LNB Output Frequency	1000 - 2050 MHz
Angle Range	(EL) 0° ~ 145° / (AZ) 390° / (SK) -60° ~ +60°
Satellite Searching Time	80 seconds (Average)
Power Requirement	DC 12V
Power Consumption	60W searching (4W standby)
Operating Temperature	-20°C ~ +60°C
Tuner	DVBS, DVBS2
GPS	24 channels
Gear Drive	Heavy Duty Full Metal

9. Caravan/Motorhome installation

9-1. Required space for SatKing ORBIT V3

Please allow that there is enough space around the SatKing ORBIT V3 for antenna section to complete a full 360° scan of the sky and return to the HOME position.

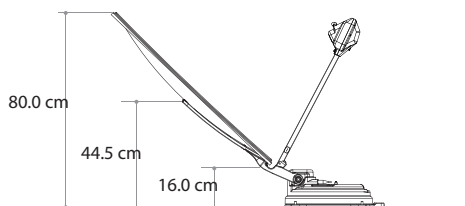
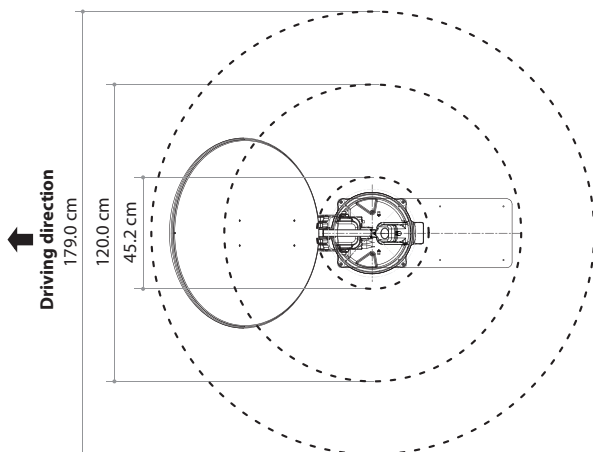
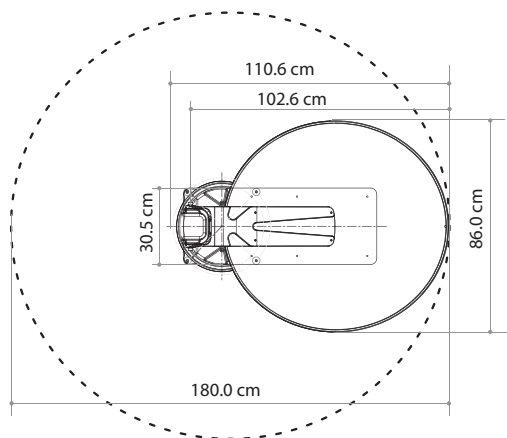

9-2. Equipment for installation

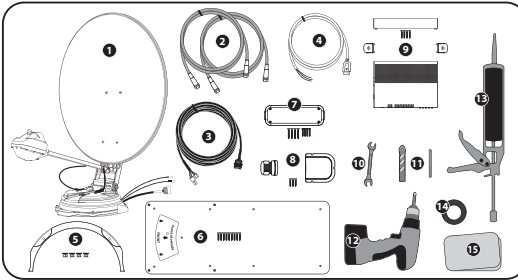

- 1 Main Unit
- 2 Signal cable x 2
- 3 Controller Cable
- 4 Power input cable
- 5 Deflector, Washer(4), M8 locking nut(4)
- 6 Mounting Plate, M4x20 (9)
- 7 Junction Box, M4x30(4), M3x18(4)
- 8 Cable gland & holder, M4x20 (3)
- 9 Controller, Controller bracket, Rear cable cover, M4x20 (4)
- 10 Spanner
- 11 2mm drill bit, 25mm drill bit
- 12 Power drill
- 13 Sika-flex
- 14 Masking tape
- 15 Cleaner

9-3. Installation

A. Mounting plate installation on a vehicle roof

A-1



Select a suitable location to install the antenna and clean the surface with Cleaner.

A-2

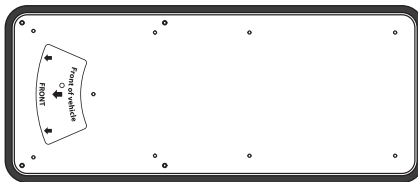

After positioning the mounting plate, apply masking tape to the outside 5mm from the edge of the plate.

A-3

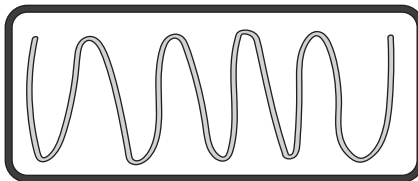

Put aside the mounting plate then to apply sika-flex at appropriate intervals to the inside of the attached tape line.

A-4

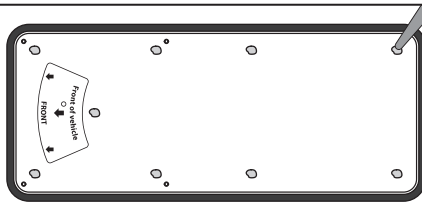

Place the mounting plate on the attached sikaflex and make 9 holes (2mm bit) with a power drill according to the fixing holes of the mounting plate, then Insert M4x20(9) screws to secure the mounting plate.

Apply enough sikaflex before and after screwing in to prevent water from entering through the holes.

A-5

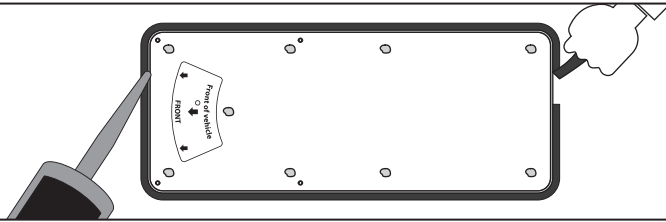

Apply sikaflex around mounting plate edge and clean away the excess sikaflex, then remove the masking tape and dry the sikaflex sufficiently.

B. Fix the antenna main unit and deflector with 4 pcs of nuts using spanner

B-2

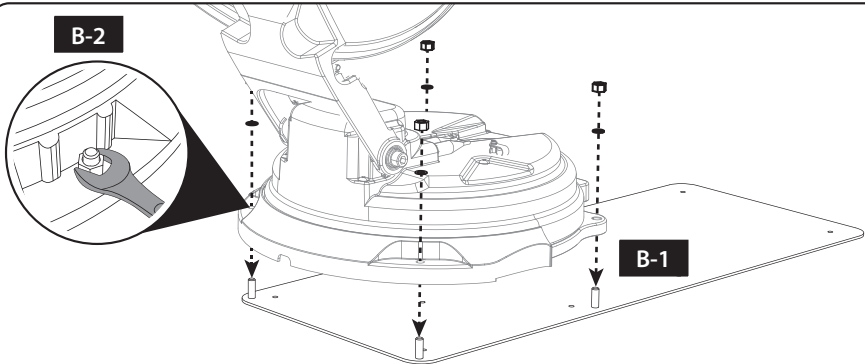

B-1. Place the antenna and deflector over the four upright bolts on the mounting plate.

B-2. Put washers and nuts into the four bolts in order and tighten firmly with a spanner.

C. Laying out junction boxes and cable holders

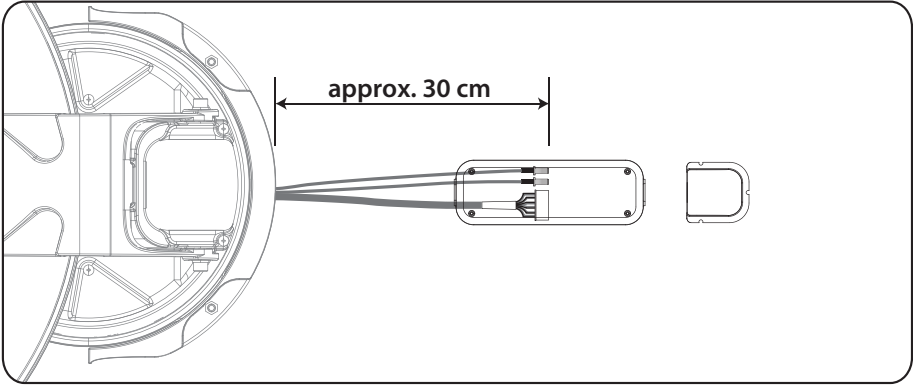

Place the center of the junction box at the location where the cable connector from the main unit is located (approximately 30 cm away from the main unit), and Place the cable holder at an appropriate location.

D. Cable holder installation

D-1

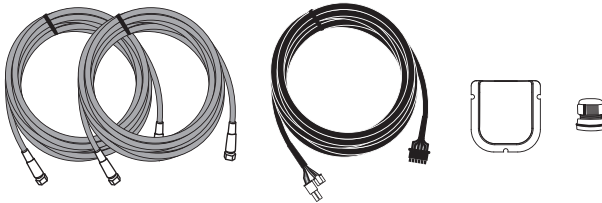

Get controller cable, signal cables, cable holder and gland

D-2

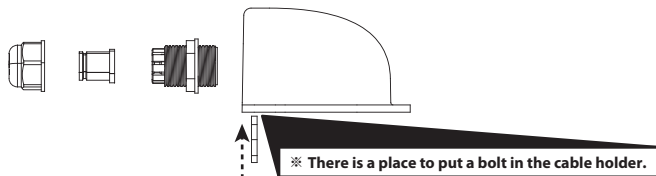

As shown in the image, disassemble the cable gland and prepare by combining the nut of cable gland with the cable holder.

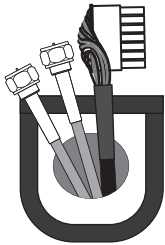
D-3

Drill a hole with a 25mm or smaller drill bit at the location where the cable holder will be installed. (at the minimum size that the controller cable connector and signal cables can pass through)

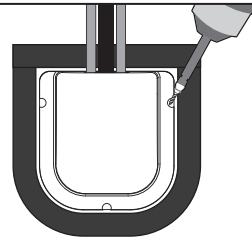
D-4

Fixing the cable holder with three M4x20 screws.

For waterproofing, apply enough sikaflex before and after fixing the screws to prevent water from entering through the screw holes, and finish the edges of the cable holder with sikaflex.

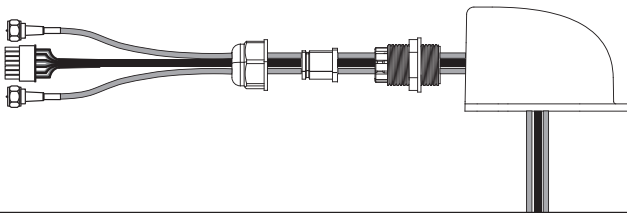
D-5

After assembling the controller cable and signal cables in the cable gland as shown in the picture, combine them with the cable holder.

E. Junction Box installation

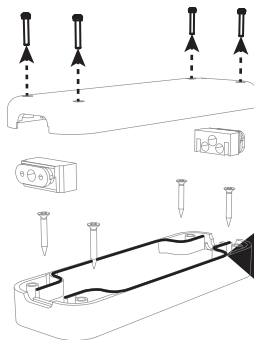

Note A waterproof seal is inserted where the top and bottom plates are joined. Be careful to position, and if the seal not sitting correctly re-attach in the correct position to maintain waterproofing.

Remove and keep the M3x18(4) screws temporarily assembled in the junction box and prepare the parts.

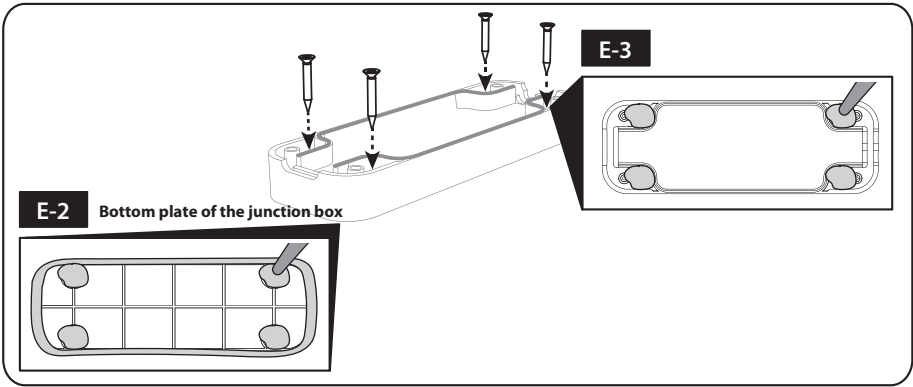

E-2 Before fixing the junction box, apply enough sikaflex to the underside of the bottom plate of the junction box to prevent water from entering the screw holes.

E-3 Fix the bottom of the junction box with M4X30(4) screws at the pre-selected location, and apply sikaflex over the screws for waterproofing.

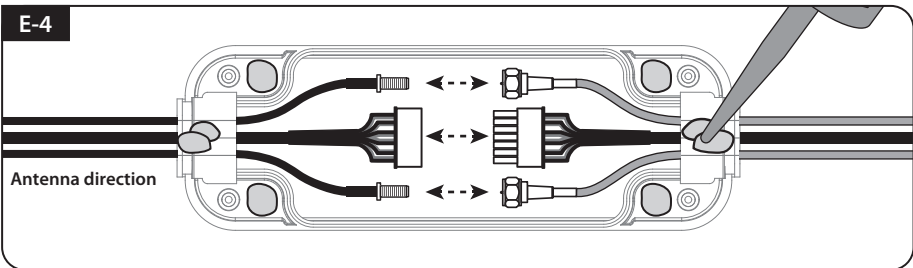

Connect the connector from the antenna, controller cable, and signal cables as shown in the image. Insert the cables into the waterproof rubber in the correct direction and apply sikaflex over the rubber for waterproofing.

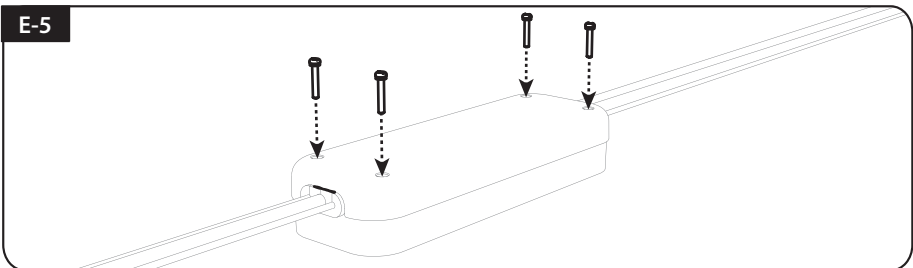

Assemble the top plate of the junction box with stored M3x18 (4) screws. Check the gap between the cables and the assembled junction box, and apply additional sikaflex.

9-4. Battery connection

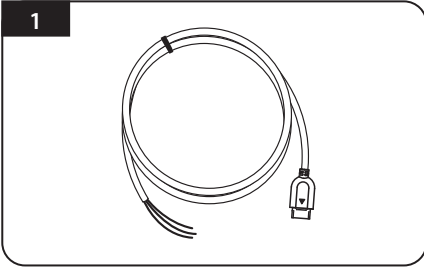

Power input cable for battery connection.

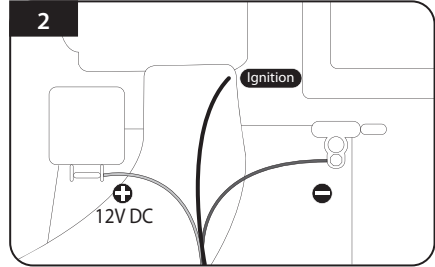

Connect power cables to the battery terminals, red-red, black-black. The yellow cable connects to an ignition or brake circuit, if none are available don't use the yellow cable.

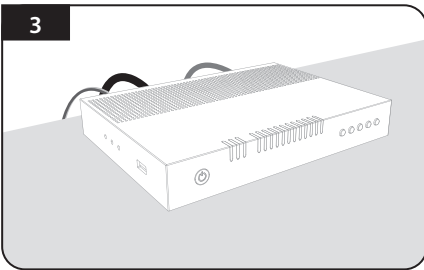

Plug the cables to the controller (Power, signal, STB and controller cables)

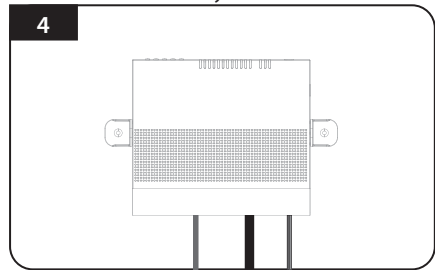

If wall mounting, fix it with provided bracket and screws. If shelf mounting use provided bracket or velcro (not supplied).

Once all cables are connected, connection part can be hidden using rear cable cover

9-5. Options

a. SKU-9160 SatKing 2x4 Satellite TV Multiswitch

The Satellite TV multiswitch allows you to increase the SatKing ORBIT V3 twin LNB outputs to 4.

This is required when you wish to use Foxtel IQ and VAST at the same time. Note you will also need to purchase 3x F to F 1 metre cables.

b. SKU-5569B SatKing mounting kit

If you would like to transfer your ORBIT V3 to another van you will need this kit, package includes:

1x Mounting plate, 1x Controller cable, 2x Receiver cables, 1x WP gland, 1x Cable holder, 4x Nuts, 1x Spanner, 1x Power cable, 1x Controller bracket, 1x Junction box

c. SKU-6605 24V to 12V Down converter

If you wish to use the SatKing ORBIT V3 on a 24v vehicle you require this device to reduce the voltage to suit the SatKing ORBIT V3 as it runs on 12V.



www.satkingorbit.com.au